

**ELEVATION**  
8/12/10

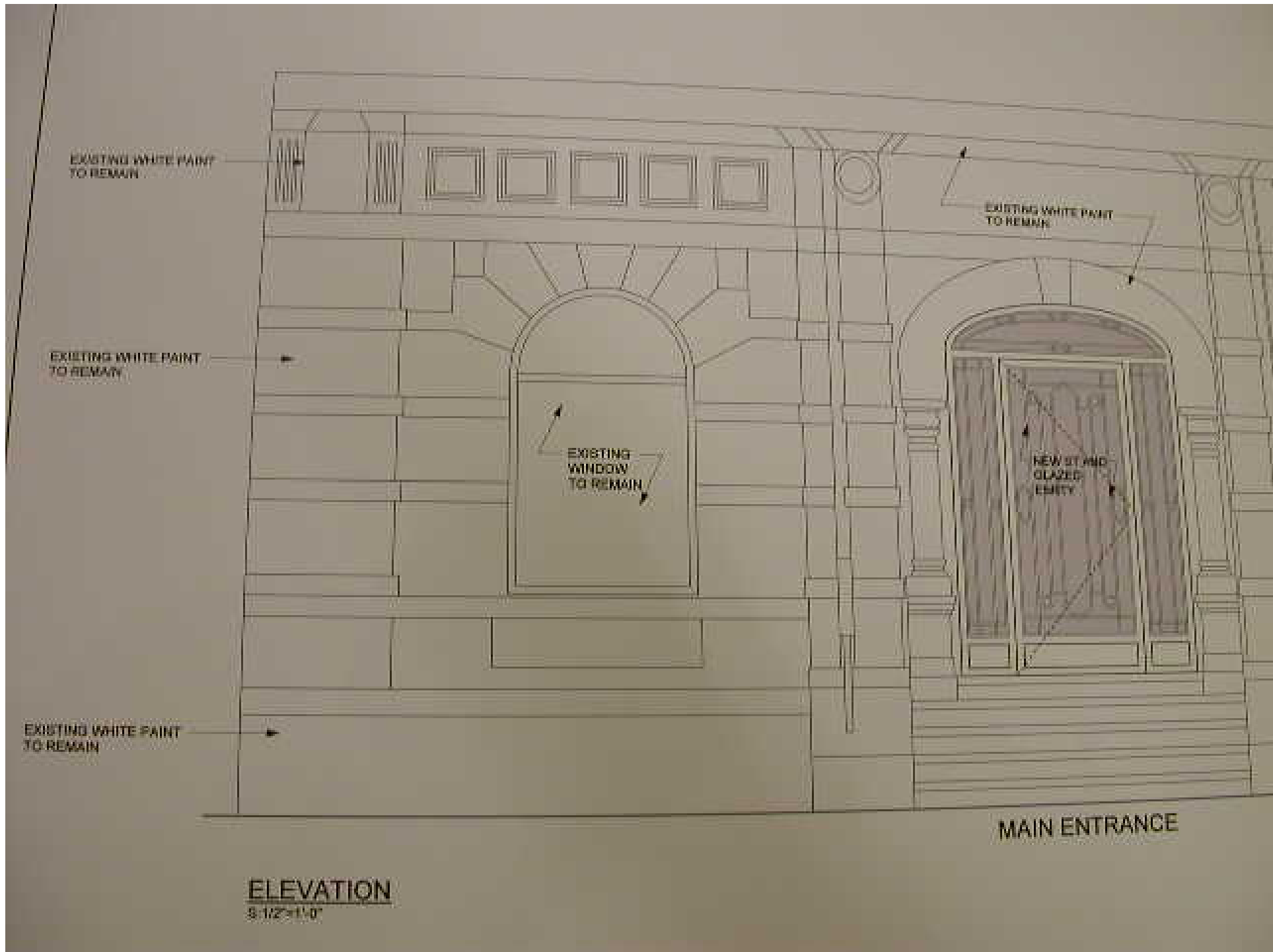

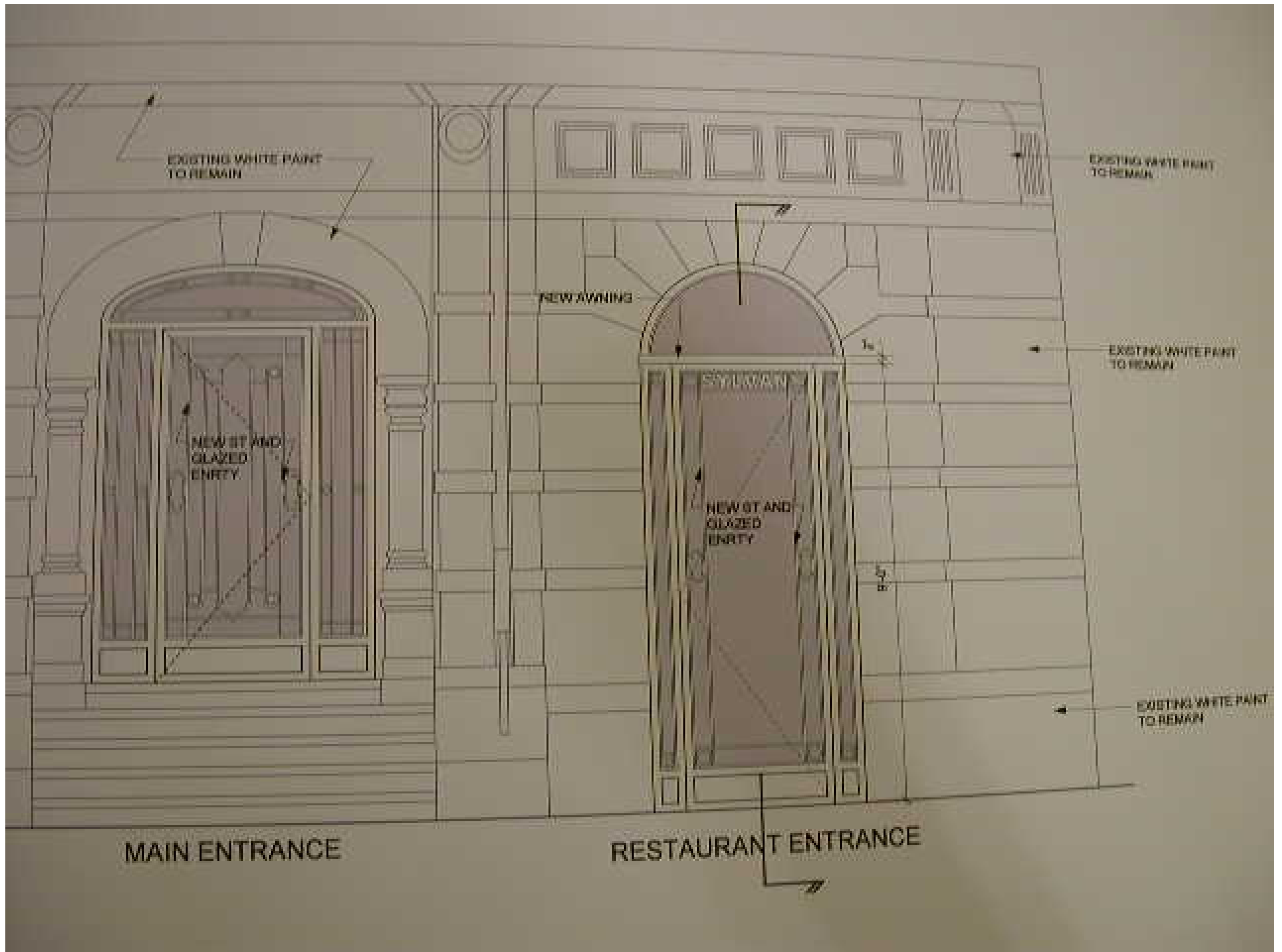

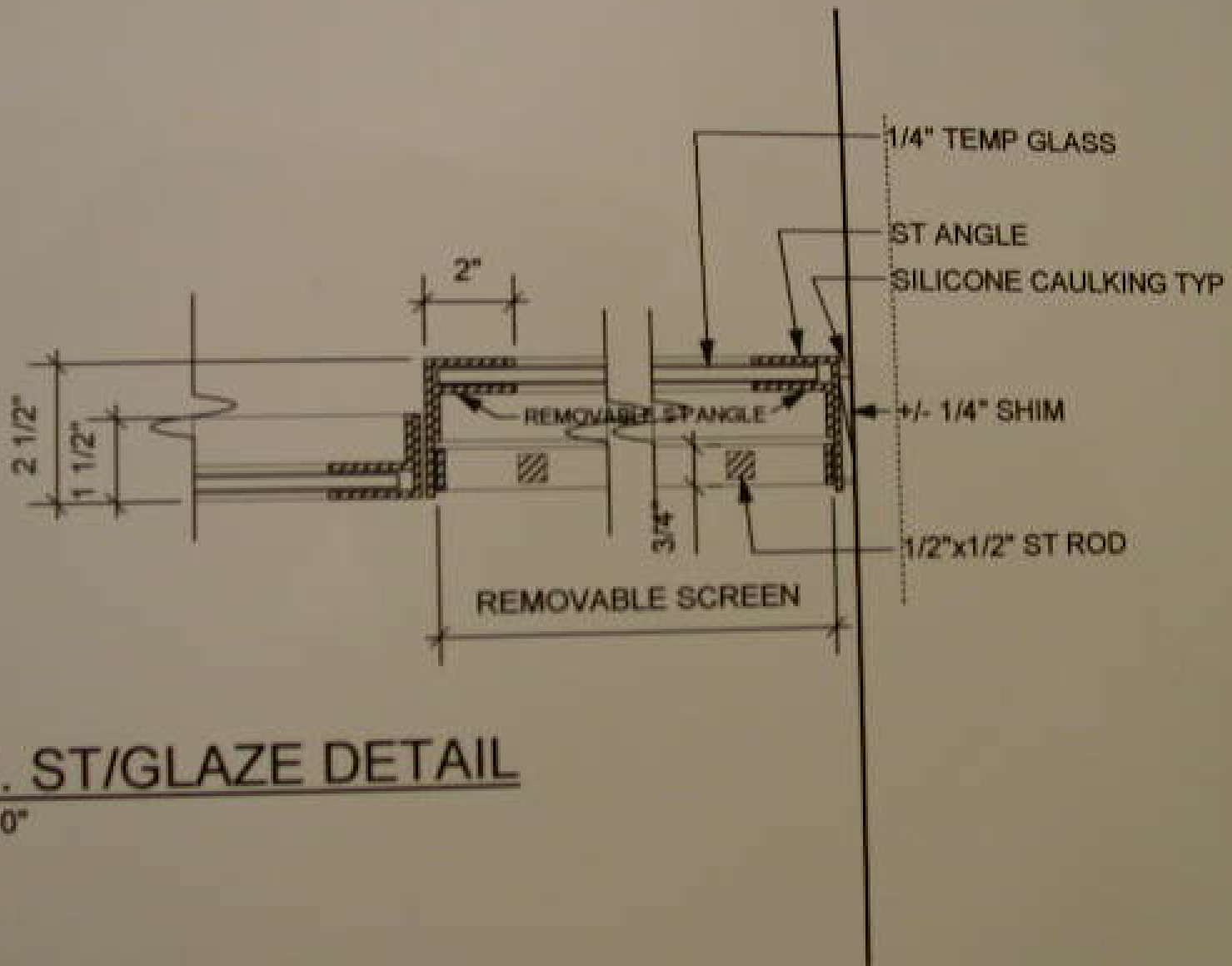

## TYP. ST/GLAZE DETAIL

S:3"=1'-0"

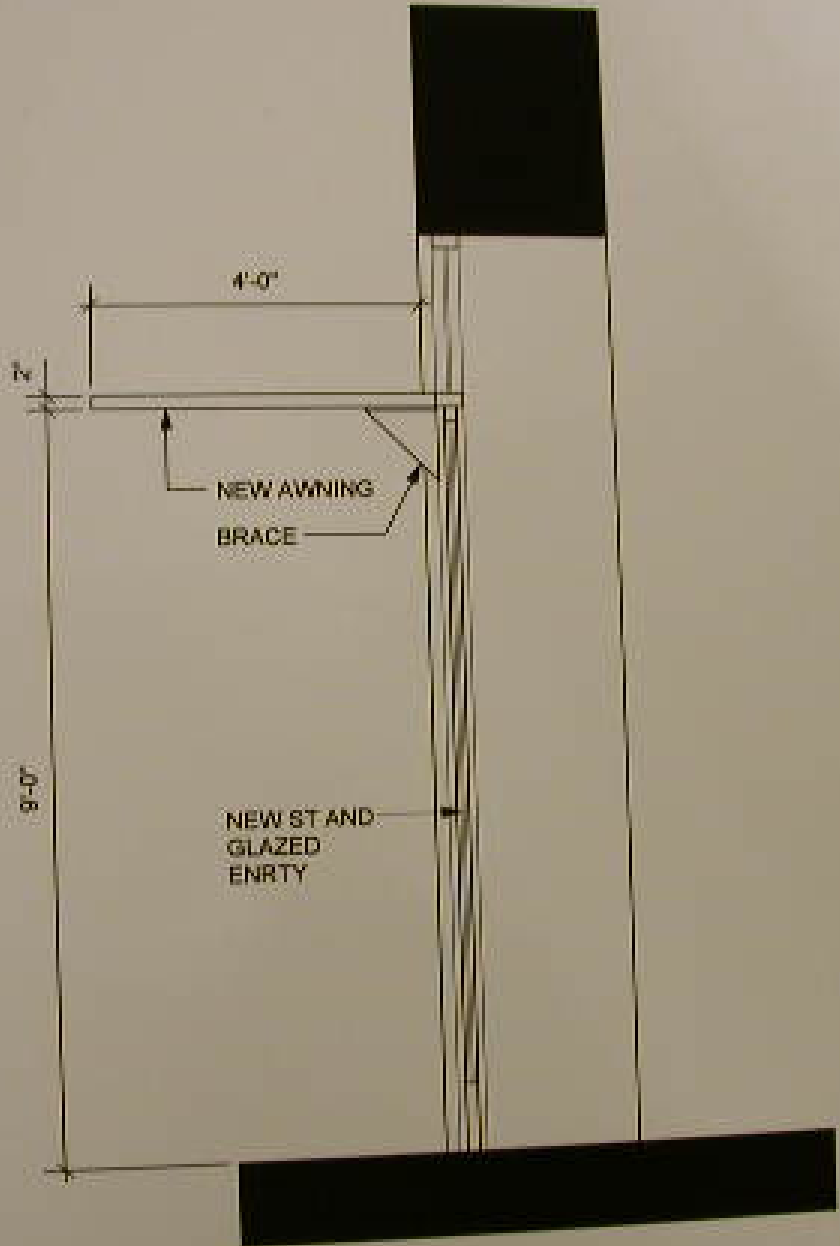

**SECTION**  
5:1/2"=1'-0"

REV





**ELEVATION**  
SECTION 1/01

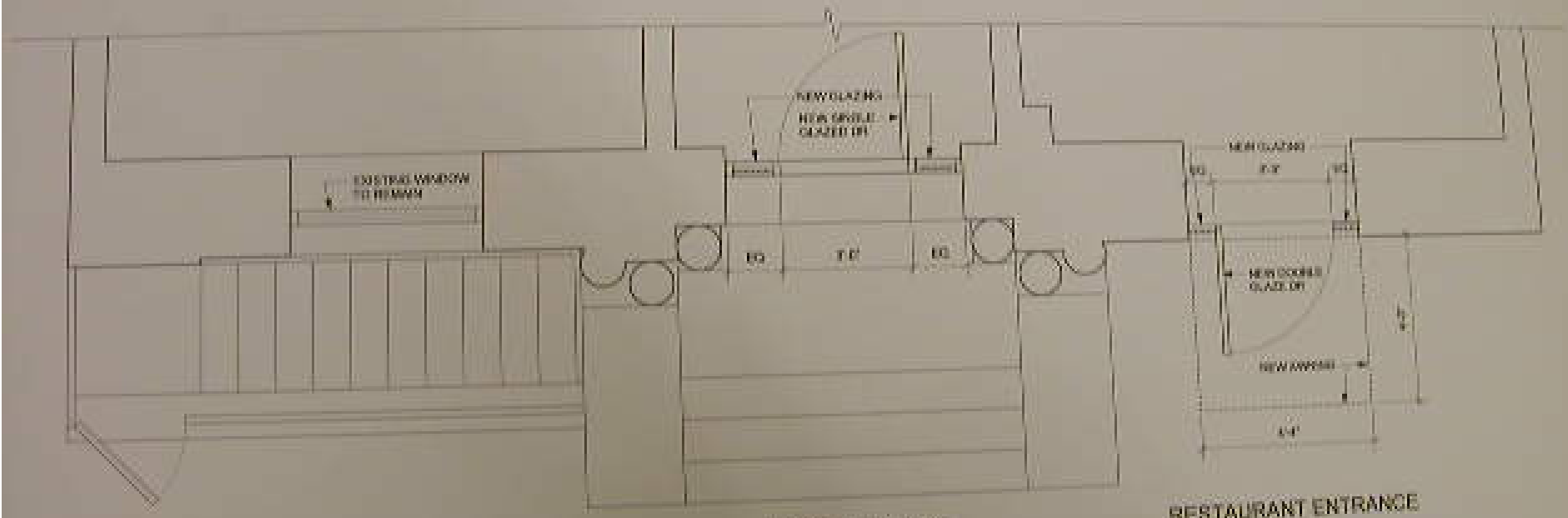

**PLAN**  
SECTION 1/01

MAIN ENTRANCE

RESTAURANT ENTRANCE

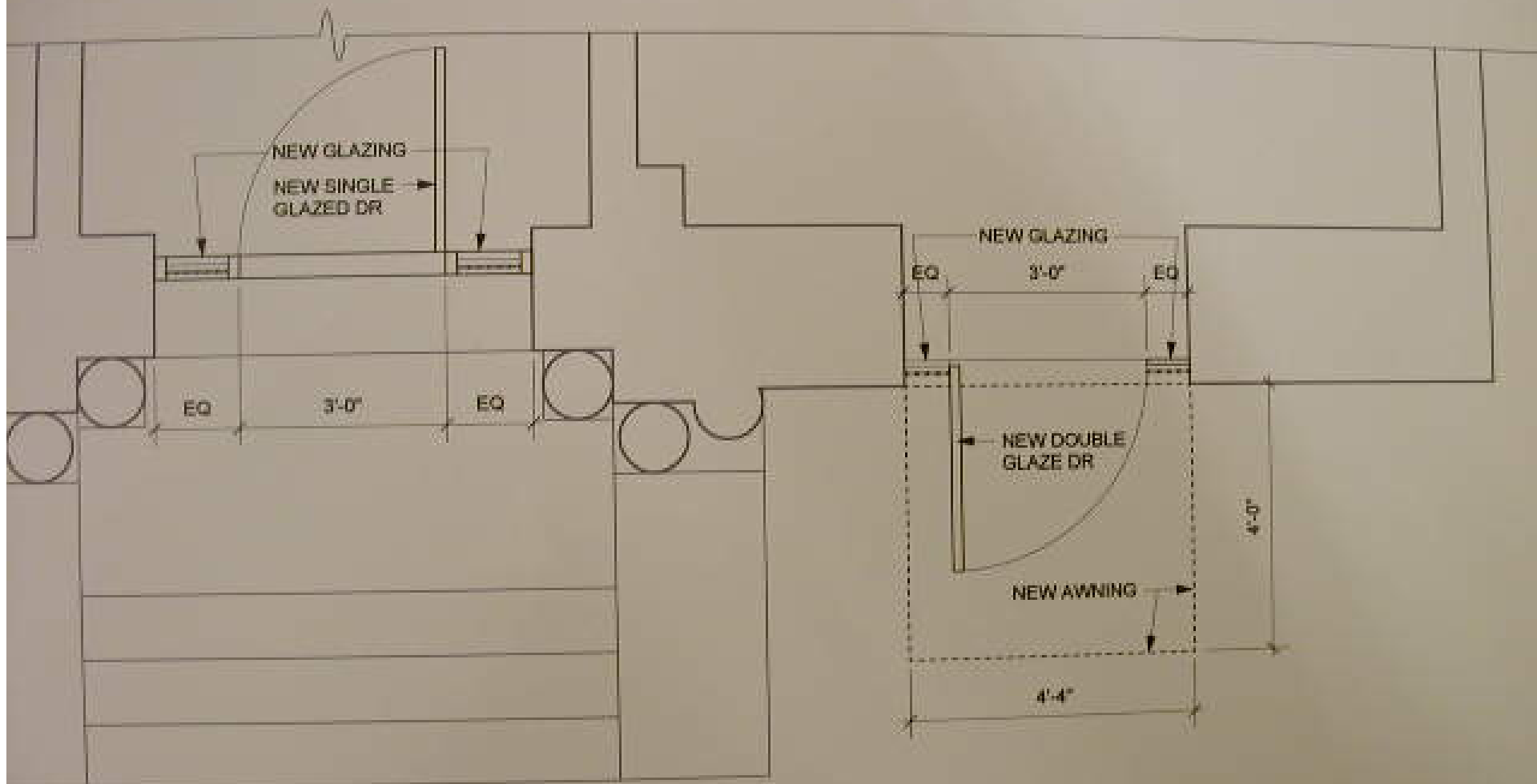

MAIN ENTRANCE

RESTAURANT ENTRANCE

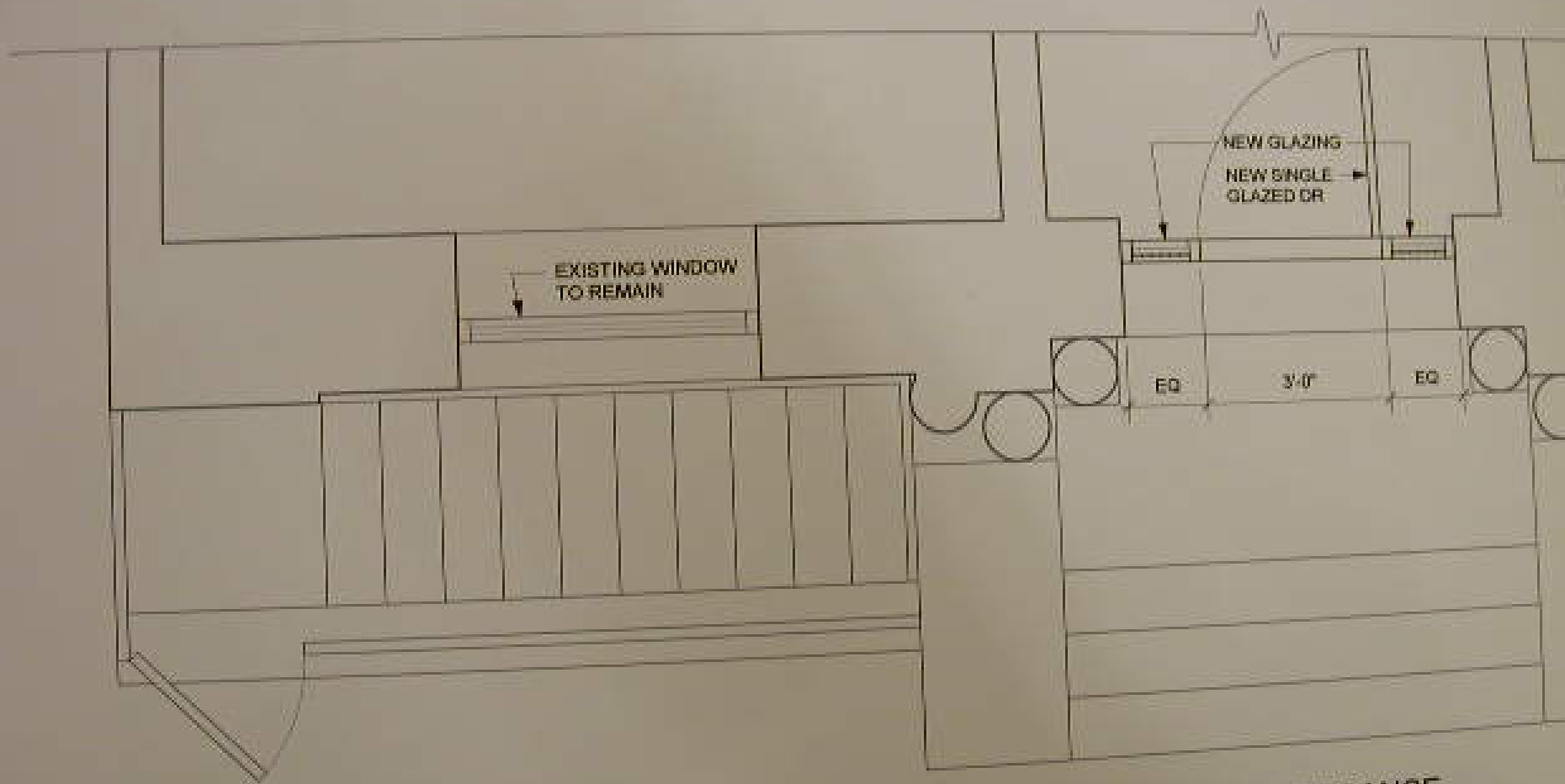

**PLAN**  
8-1/2"=1'-0"

MAIN ENTRANCE